

2-SIDED AND 3-SIDED ALCOVE DESIGNS

1024



**Important**

1. When you receive your Acrylic Tray and Liner, check that they are the correct type, size and free of freight damage or any other defect.
2. Advise Newline on 0508 639 5463 if any damage has occurred within 8 hours of receiving the goods so this can be rectified.
3. It is essential that items 1 and 2 are followed as installation of incorrect or damaged product will void a warranty cover.

### BEFORE YOU START, READ THROUGH INSTRUCTIONS TO UNDERSTAND SCOPE

#### WARRANTY

- Products supplied are free of defects with a 5 year cover.
- Installations must conform to “**Newline Pre-Install Specifications**” and these instructions for the warranty to be valid.
- Hot water temperature must be regulated to 55 degrees to comply with the warranty.
- Full warranty information can be obtained at [www.newline.nz/warranty-information/](http://www.newline.nz/warranty-information/)

#### HEALTH AND SAFETY

- Keep room well ventilated to dissipate glue vapours.

#### TOOLS REQUIRED

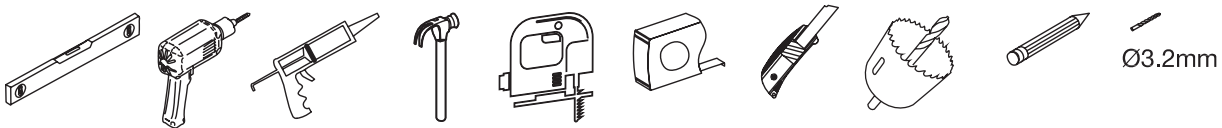

#### INSTALLATION INSTRUCTIONS REFER TO:

Newline Acrylic Low-Profile Shower Tray } (Size and Type as order)  
Newline Acrylic Shower Liner }

#### ADDITIONAL ITEMS SUPPLIED IN PACKAGE

1 x Easyclean Waste

1 x Maxbond Cartridge (Glue for Tray)

Acrylic Liner Shower Bond Cartridges: 3 cartridges for 2-sided shower and 4 cartridges for 3-sided.

#### IMPORTANT!

**Working with Acrylic Materials:** Take care not to chip or scratch the surfaces.

**Drilling:** Use twist drills or hole saws suitable for wood. Work must be well supported on both sides around the holes to be drilled. Sharp drills are essential to achieve a clean cut.

**Cutting of Liner:** This is not normally necessary provided walls and floor are to specs. Small corrections to an edge can be achieved with a sharp plane.

**NEWLINE RECOMMENDS A SKILLED TRADESMAN ACQUAINTED WITH SHOWER INSTALLATIONS TO ENSURE THE VERY BEST OUTCOME.**

The builder is responsible for these steps to enable a successful shower installation.

**The Floor:** Must be flat, level with no deflection. Remedial action may require.

1. Additional framing to support the floor.
2. Grinding, sanding or levelling compound to establish level.
3. Packers or expandable foam are not acceptable for levelling a tray.

#### Wall Framing

1. The walls must be flat, plumb with internal corners at 90 degrees.
2. The tray requires a horizontal batten in the wall for support (Diagram A on Page 4).
3. Solid fixing for shower wall profile channels is flush off outside of shower tray edge, must be 90mm faced crosswise.
4. 3-Sided Alcove Tray: Page 5 gives specific details fo aligning tray and framing.

#### The Wall Board

1. This must be an accredited for “Wet Areas” complying with the NZ Building Code.
2. This system is based on 10mm thickness and must have absorbent surface for glues.
3. There must be no paint, stopping material, sealer or sanding dust on the surface.

**Plumbing:** All waste and supply installation must be undertaken by a licenced plumber.

## IMPORTANT INFORMATION

### WALLBOARD LINING OF SHOWER WALLS

**Two-Sided:** This can be installed after wallboard lining provided all frame detailing is complete. Place the tray against the lined wall and mark 4mm above the tray upstand and trim this lower section of wallboard out.

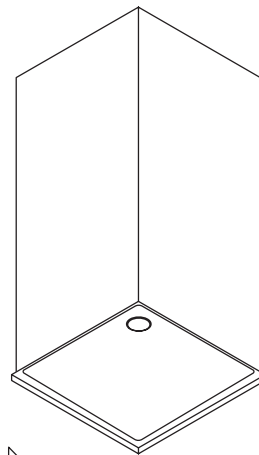

**Three-Sided Alcove:** It is more practical to leave the lining off and install the tray first and then complete lining.

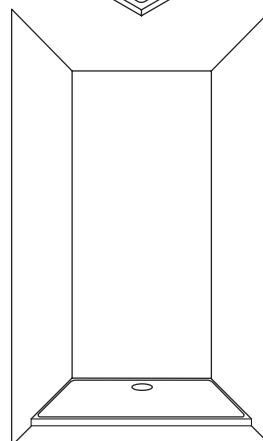

**NEXT PAGE 3-SIDED ALCOVE:** Full guidance by Table 1 and Diagram B

**Diagram A**

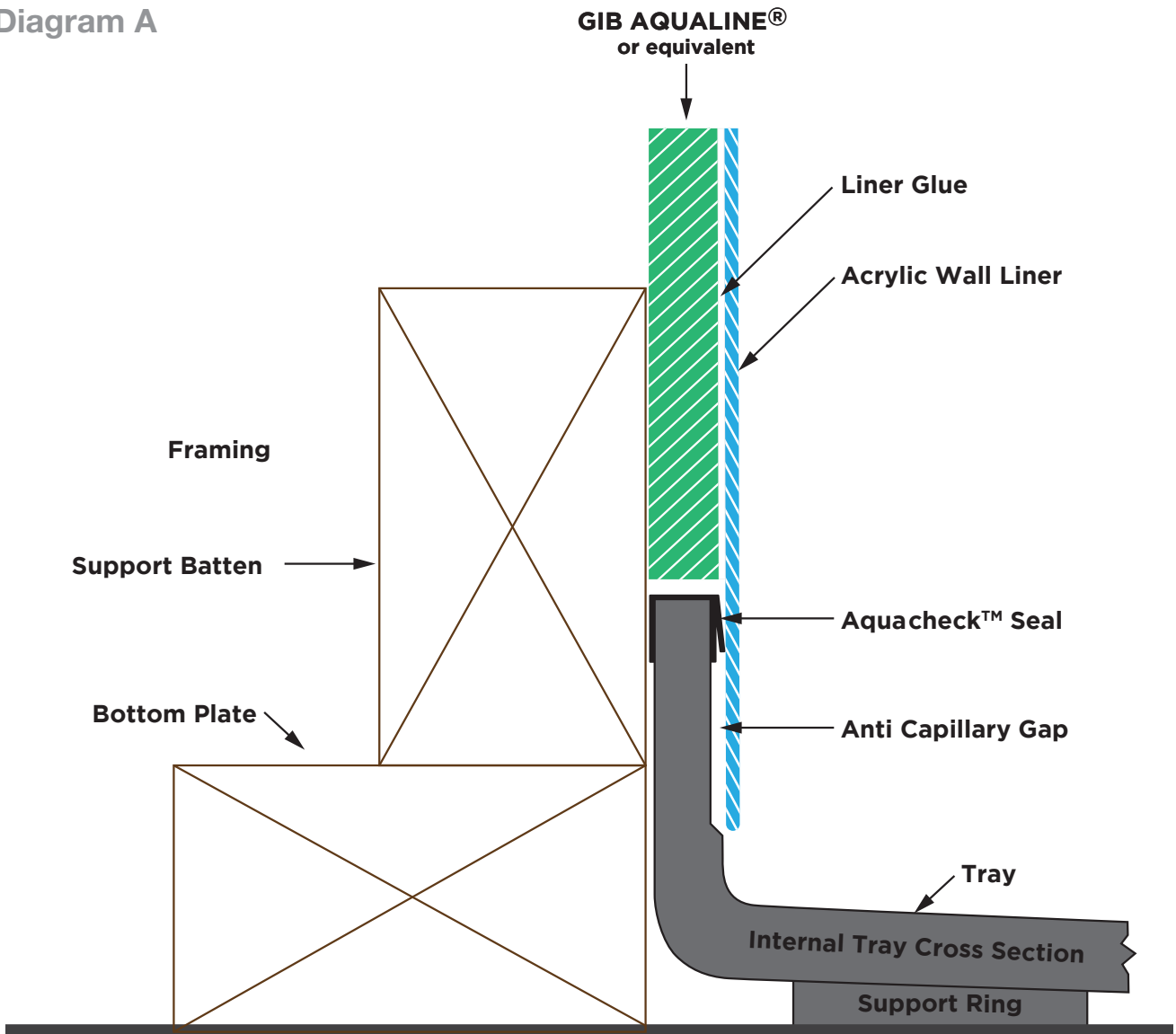

**STEPS TO UTILIZE TABLE 1**

1. Use the specifications to position framing and tray so the Gib lined walls measure across as per the Table 1.
2. The tray dimensions may vary +/- 3mm. This is within manufacturing tolerance.
3. Framing may have to be rebated to adapt to tray variances to ensure tray aligns to wall board and acrylic lining fits correctly.
4. It is important that the acrylic liner has a clearance at the back wall for glue and slight variances to plumb and straight walls. This will be approx. 5mm.

**IMPORTANT!** Alcove walls if not plumb and flat can double the risk of the liner not fitting even with the tray installed correctly to frame at the floor as outlined in Table 1.

**3-SIDED ALCOVE LOW PROFILE ACRYLIC TRAYS**

Identify actual Width & Depth applicable to your installation

Tray Size	Tray Width +/- 3mm	Frame to Frame	Gib Lining to Lining	Liner Back Wall O/A width +/-1mm
810 x 810	810	810	790	785
900 x 900	900	900	880	875
1000 x 1000	1000	1000	980	975
1200 x 915	1200	1200	1180	1175

**Diagram B**

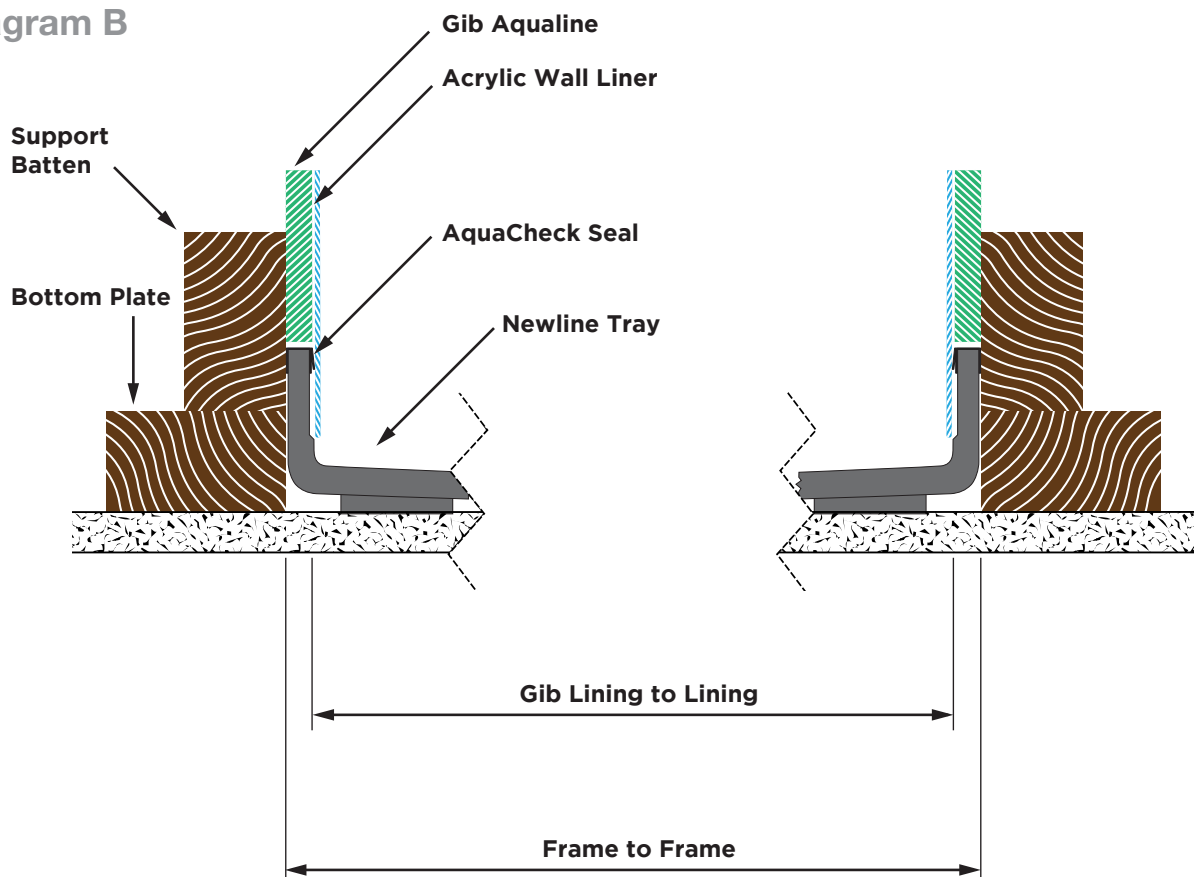

Tray dimensions may vary +/-3mm. This is within manufacturing tolerance. Framing may have to be rebated to ensure lining to lining dimensions are as per Table A, as this is critical for correct liner installation.

**STEP 1**

- Peel protective film off the tray and check there are no defects. Cut and tape down a section of the tray box to protect the surface during installation and stop any item going down the drain.
- Fit up tray. Ensure the “end blocks” at each of the upstand are flush or slightly under the outside of wall board. Trim any framing that is holding the tray out from correct position.

**Diagram C**

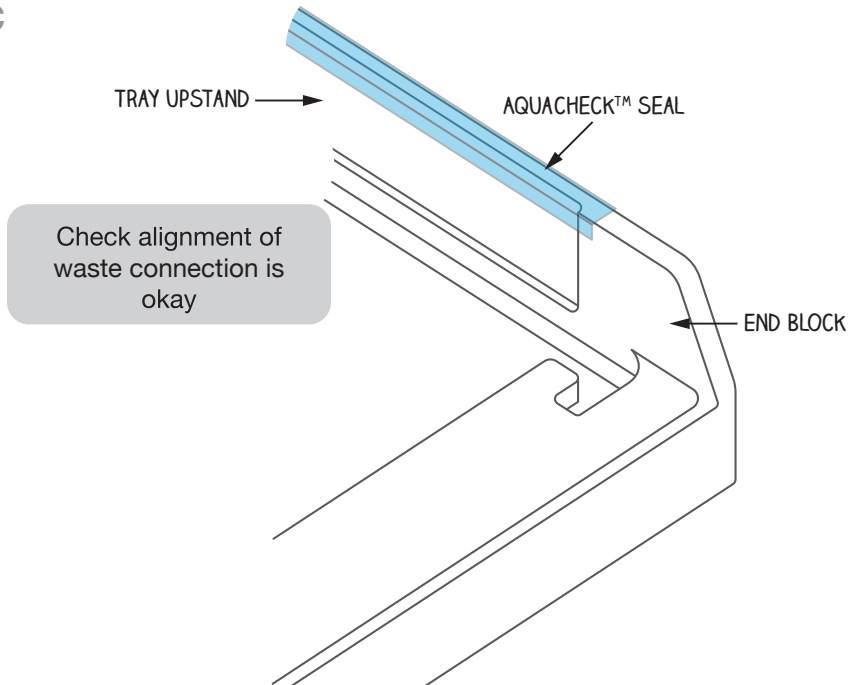

**STEP 2**

- Glue the tray down with Maxbond at the rings underneath. Apply a silicone seal underneath the outside edge and place and hold the tray in position against the wall framing and with a little downward weight.  
**NOTE:** The Maxibond is best applied on the inside and outside of the rings, 50mm long on opposite sides as shown in the below diagram. Use sufficient glue to slump to floor when placed the right way up. Do not stand on tray for 24 hours minimum after installation.
- Connect the Easy Clean waste.

**Diagram D**

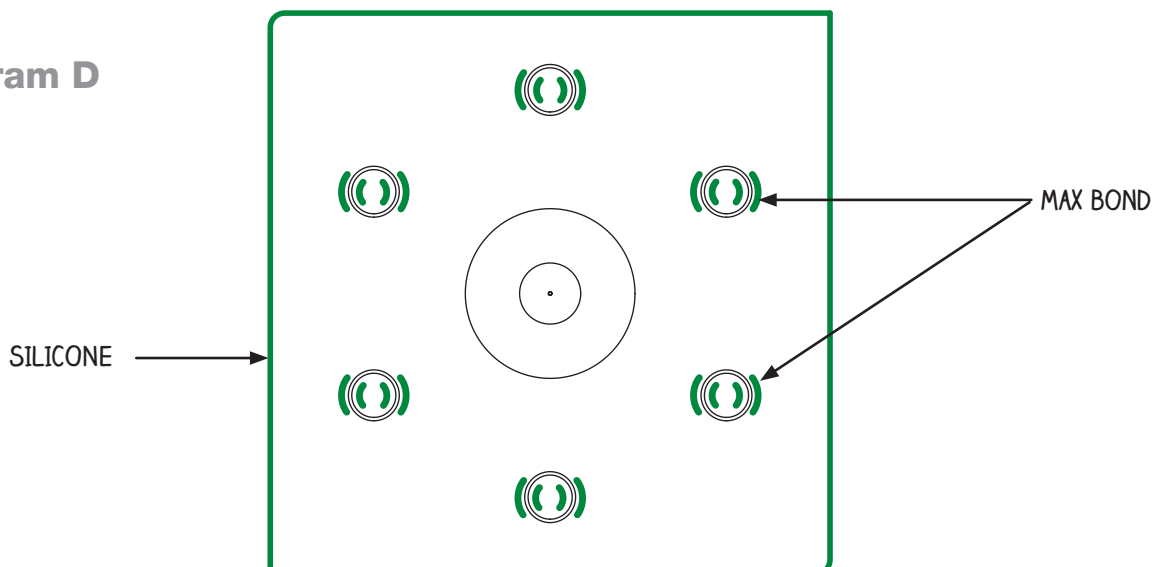

### STEP 3: Wall Liner Installation

#### Marking Out

- Stand the liner into position and check lower edge for fit to tray and if needed trim lower edge with a sharp plane
- With a soft pencil or masking tape spot the outside boundary of the liner.
- Measure all plumbing fittings on the wall. Transfer these to the liner and drill with a hole saw.
- Mark out the glue pattern on the wall. 30mm in from the perimeter and at 75mm apart in vertical lines. Also one horizontal line 15mm above the Aquacheck.

**Diagram E**

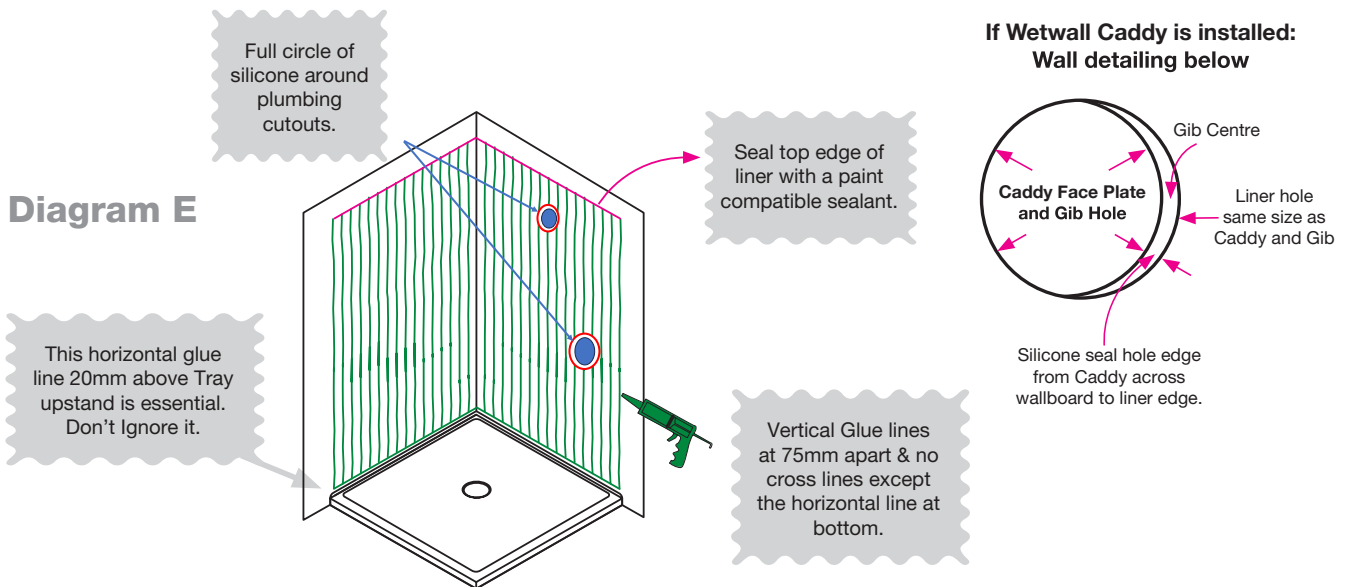

#### Bonding/ Sealing

- Apply a secondary silicone seal and full cover of raised end block as **Diagram F**.
- Follow through quickly and apply showerbond to marked lines. If installing a moulded liner apply glue to the adhering face of the mould edges also.

**Diagram F**

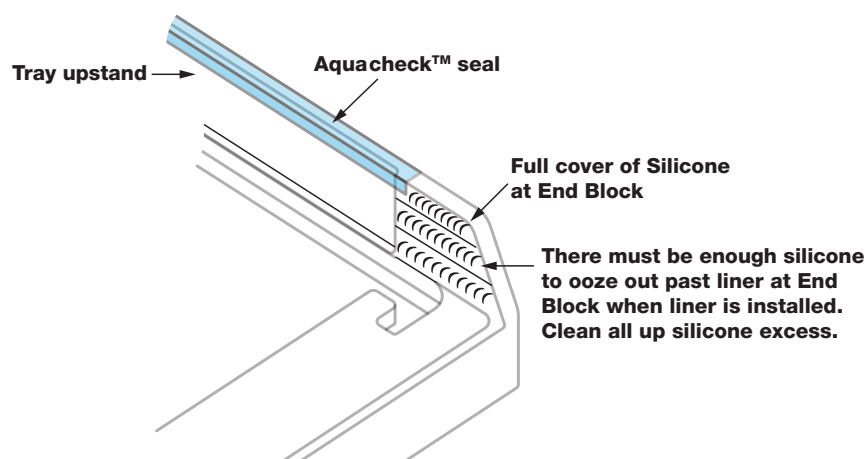

#### Install Wall Liner

- Position liner on the wall with the inner corner first and working out from there.
- From the inside corner apply pressure with a roller or shaped board covered in soft material and work across the surface to flatten out the glue. Brace any area that maybe required and take specific attention to the area of the horizontal glue line just above the Aquacheck seal. Leave bracing in place for 12 hrs.

#### Corner Mould Details

- Apply pressure around the detailing of this mould to ensure it is against the wall board.
- **IMPORTANT!** The glass shelves must be fitted when liner is in place to compress the glue so the glass fits.

**CONTACT**

**NEWLINE**  
*for a lifetime!*

54 Unutoto Place, Tauriko, Tauranga, 3171

Freephone: 0508 639 5463 Phone: 09 444 2053

Email: [info@newline.co.nz](mailto:info@newline.co.nz) [newline.nz](http://newline.nz)